

Datasheet

Subject to technical alteration
Issue date: 06.04.2016



Application

Combined sensor for measuring relative humidity and temperature in rooms (e.g. office or conference rooms). Designed for locking on control and display systems. Additionally, the device can be supplied with a passive temperature sensor e.g. PT100, PT1000, NTC10k etc.

Types Available

Room sensor temperature + humidity – active VV 2x 0..10 V | AA 2x 4..20 mA

FTW04 VV
FTW04 AA

Options: Additional passive temperature sensor (type VVS|AAS)
eg: PT100/PT1000/NI1000/NI1000TK5000/LM235Z/NT... and other sensors on request

Security Advice – Caution



The installation and assembly of electrical equipment should only be performed by authorized personnel.

The product should only be used for the intended application. Unauthorised modifications are prohibited! The product must not be used in relation with any equipment that in case of a failure may threaten, directly or indirectly, human health or life or result in danger to human beings, animals or assets. Ensure all power is disconnected before installing. Do not connect to live/operating equipment.

Please comply with

- Local laws, health & safety regulations, technical standards and regulations
- Condition of the device at the time of installation, to ensure safe installation
- This data sheet and installation manual

Notes on Disposal



As a component of a large-scale fixed installation, Thermokon products are intended to be used permanently as part of a building or a structure at a pre-defined and dedicated location, hence the Waste Electrical and Electronic Act (WEEE) is not applicable. However, most of the products may contain valuable materials that should be recycled and not disposed of as domestic waste. Please note the relevant regulations for local disposal.

Remarks to Room Sensors

Location and Accuracy of Room Sensors

The room sensor should be mounted in a suitable location for measuring accurate room temperature. The accuracy of the temperature measurement also depends directly on the temperature dynamics of the wall. It is important, that the back plate is completely flush to the wall so that the circulation of air occurs through the vents in the cover. Otherwise, deviations in temperature measurement will occur due to uncontrolled air circulation. Also the temperature sensor should not be covered by furniture or similar devices. Mounting next to doors (due to draught) or windows (due to colder outside wall) should be avoided.

The temperature dynamics of the wall will influence the temperature measurement. Various wall types (brick, concrete, dividing and hollow brickwork) all have different behaviours with regards to thermal variations.

Surface and Flush Mounting

The temperature dynamics of the wall influence the measurement result of the sensor. Various wall types (brick, concrete, dividing and hollow brickwork) have different behaviours with regard to thermal variations. A solid concrete wall responds to thermal fluctuations within a room in a much slower way than a light-weight structure wall. Room temperature sensors installed in flush boxes have a longer response time to thermal variations. In extreme cases they detect the radiant heat of the wall even if the air temperature in the room is lower for example. The quicker the dynamics of the wall (temperature acceptance of the wall) or the longer the selected inquiry interval of the temperature sensor is the smaller the deviations limited in time are.

Build-up of Self-Heating by Electrical Dissipative Power

Temperature sensors with electronic components always have a dissipative power, which affects the temperature measurement of the ambient air. The dissipation in active temperature sensors shows a linear increase with rising operating voltage. This dissipative power has to be considered when measuring temperature. In case of a fixed operating voltage ($\pm 0,2$ V) this is normally done by adding or reducing a constant offset value. As Thermokon transducers work with a variable operating voltage, only one operating voltage can be taken into consideration, for reasons of production engineering. Transducers 0..10 V / 4..20 mA have a standard setting at an operating voltage of 24 V =. That means, that at this voltage, the expected measuring error of the output signal will be the least. For other operating voltages, the offset error will be increased by a changing power loss of the sensor electronics. If a re-calibration should become necessary later directly on the sensor, this can be done by means of a trimming potentiometer on the sensor board.

Remark: Occurring draft leads to a better carrying-off of dissipative power at the sensor. Thus temporally limited fluctuations might occur upon temperature measurement.

Application Notice for Humidity Sensors

Refrain from touching the sensitive humidity sensor/element. Touching the sensitive surface will void warranty.

For standard environmental conditions re-calibration is recommended once a year to maintain the specified accuracy.

When exposed to high ambient temperature and/or high levels of humidity or presence of aggressive gases (i.e. chlorine, ozone, ammonia) the sensor element may be affected and re-calibration may be required sooner than specified. Re-calibration and deterioration of the humidity sensor due to environmental conditions are not subject of the general warranty.

Technical Data

Measuring values		temperature, humidity
Output voltage	VV VVS	2x 0..10 V 2x 0..10 V (min. load 10 k Ω) + passive sensor,
Output Amp	AA AAS	2x 4..20 mA 2x 4..20 mA (max. load 800 Ω) + passive sensor
Power supply	VV VVS AA AAS	15..24 V = ($\pm 10\%$) or 24 V ~ ($\pm 10\%$) 15..24 V = ($\pm 10\%$)
Power consumption	VV VVS AA AAS	max. 0,3 W (24 V =) 0,5 VA (24 V ~) max. 1 W (24 V =)
Measuring range temperature	active passive	0..+50 °C depending on used sensor
Measuring range humidity		0..100% rH non-condensing
Accuracy temperature	active passive	$\pm 0,5$ °C (typ. at 25 °C) depending on used sensor
Accuracy humidity		$\pm 2\%$ between 10..90% rH (typ. at 21 °C)
Enclosure		PC, pure white
Protection		IP30 according to EN 60529
Cable entry		predetermined breaking points at the bottom, top, opening at the rear
Connection electrical		terminal block, max. 1,5 mm ²
Ambient condition		-20..+70 °C
Weight		80 g

Mounting Advices

The device may be installed in a voltage free condition only.

The device can be installed on a flush-mounted box or directly onto the wall.

If installed on a flush-mounted box, seal the pipe to eliminate drafts

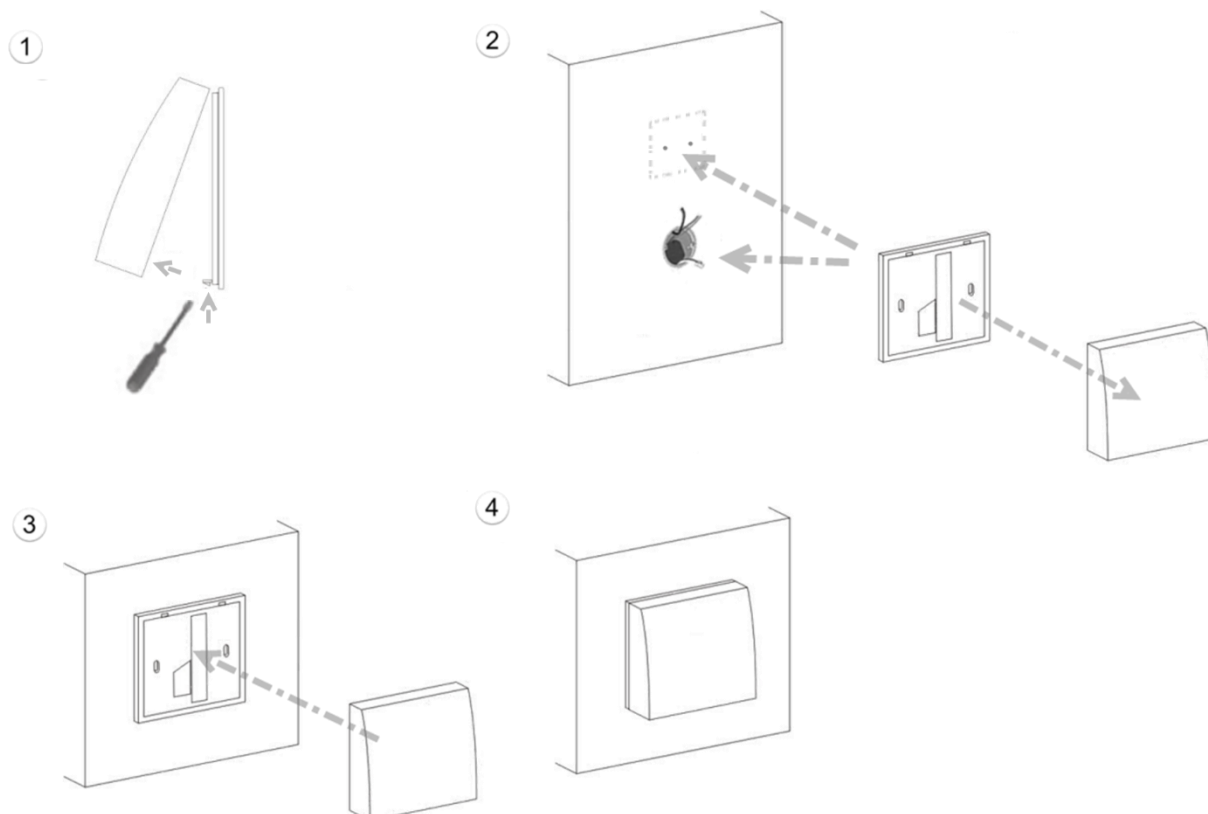

Connection Plan

Please note the revision at the terminal assignment.

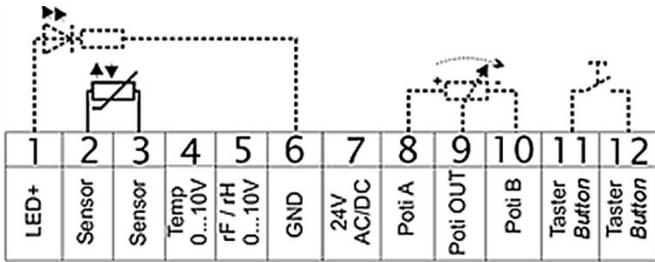

FTW04 VVS

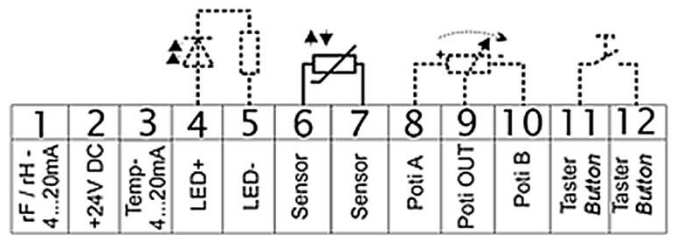

FTW04 AAS

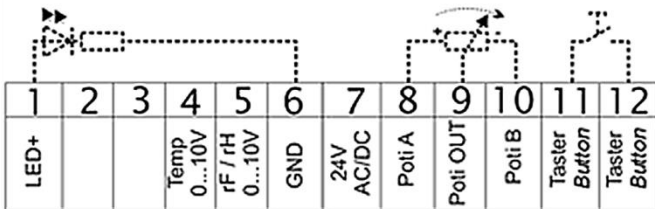

FTW04 VV

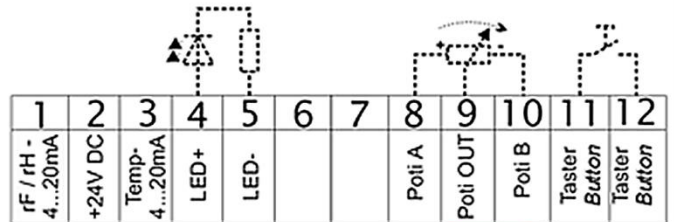

FTW04 AA, #609555 valid-from production date 15199

thermokon

Type: FTW04AA
 rH: 0..100%
 Temp.: 0..+50 °C
 Out: 4...20 mA / 4...20 mA
 Art.-Nr.: 0000000609555
 Made in Germany
FCC This device complies with FCC rules part 15, subpart B, class B

15199

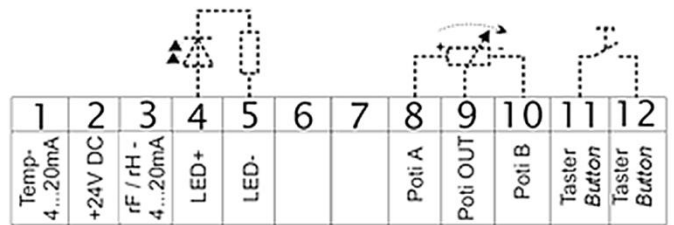

FTW04 AA, #429962 valid-to production date 15190

Note (type FTW04-AA/AAS)

When only using the temperature output, the humidity output must always be connected to mass/GND of the analog input module.

Offset adjustment

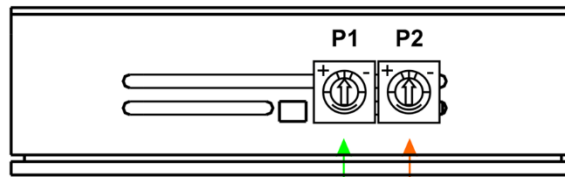

±4 % Offset rh

±3 °C Offset temperature

Dimensions (mm)

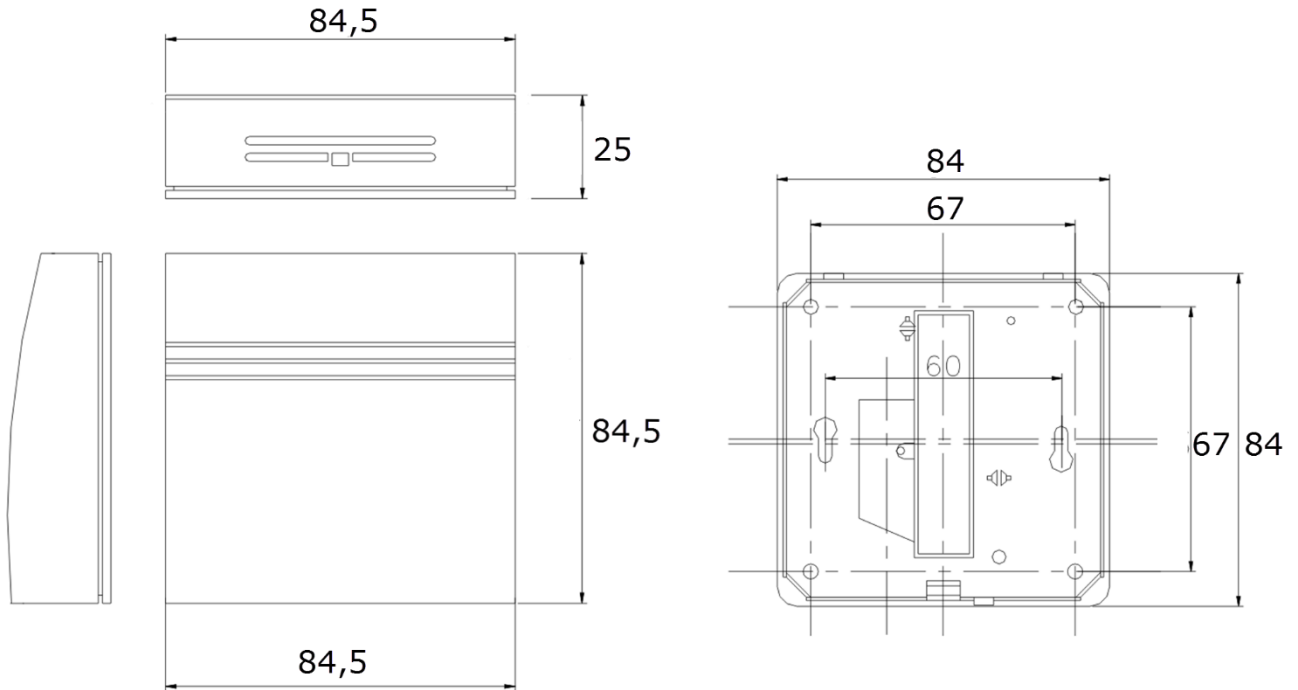

Accessories (optional)

Raw plugs and screws (2 pcs. each)
 Frame for surface mounting WRF04

Item No. 102209
 Item No. 111584